

Parrot

BEBOP 2 DRONE



USER GUIDE

TABLE OF CONTENTS

Downloaded from www.vandenborre.be

Before you begin.....	4
Package contents.....	4
Installing the propellers.....	4
Charging the battery.....	5
Installing the battery.....	5
Switching on/off the Parrot Bebop 2.....	6
Downloading the application.....	6
Connecting a smartphone.....	7
Preflight check.....	8
Updating the Parrot Bebop 2.....	9
Via the app.....	9
Via USB.....	9
Flying	11
Piloting screen.....	11
Calibrating the Parrot Bebop 2.....	12
Flat trim.....	12
GPS signal.....	12
Taking off.....	13
Movements.....	13
Landing.....	16
Pre-programmed acrobatics.....	16
Battery.....	16
Return home.....	16
Map mode.....	17
Photos and videos.....	18
Retrieving photos and videos.....	19
Settings.....	21
Piloting settings.....	21
Position, distances and limits.....	22
Recording settings.....	22
Return home.....	25

Image settings.....	25
Network settings.....	27
Information.....	28
Drone Academy.....	30
Creating a user account.....	30
Registering a drone.....	30
Managing your profile.....	30
Consulting shared flights.....	30
Consulting and sharing your flights.....	31
Troubleshooting.....	32
LED behaviour.....	32
Spare parts.....	32
More information.....	33
General information.....	34
Safety precautions and maintenance.....	34
Warning on invasion of privacy	35
Warranty.....	35
Wi-Fi.....	35
Battery.....	35
Modifications.....	36
Disposal of this product at the end of its life	36
Declaration of conformity.....	36
Registered trademarks	37

Before you begin

For easy reading, iPhone®, iPad® and other compatible telephones or tablets are referred to as 'smartphones' in the manual.

Package contents

Parrot Bebop 2	Battery 2700mAh
Propellers (x 8)	Propellers mounting tool
Charger	Plug converters (x 4)
Charger cable	USB / Micro USB cable
Lens cap	Quick start guide

We recommend you install the lens cap cover when transporting your Parrot Bebop 2 in order to protect the camera lens.

Installing the propellers

1. Remove the propellers from the packaging and locate the propeller mounting tool.
2. Install the new propellers:
 - place the propellers with a hole in the middle on the motors with a protruding axle (front right and rear left motors);
 - place the propellers without a hole on the motors without protruding axle (front left and rear right motors).
3. Lock the propellers with the propellers mounting tool.
4. To change the propellers perform the process in reverse.

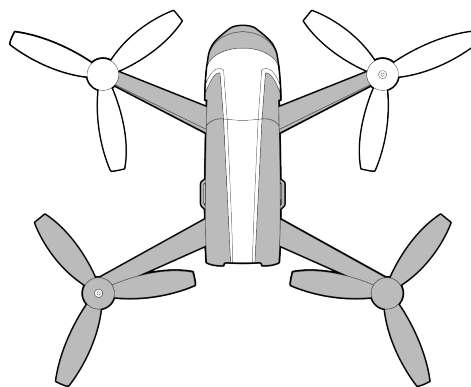
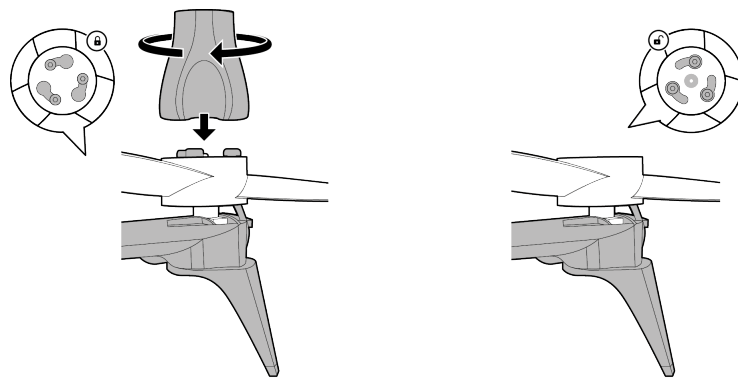

Charging the battery

1. Insert the plug converter corresponding to your country to the charger.
2. Plug the battery into the charger.
3. Plug the charger into an electrical wall socket.
 - > The charger LED lights up in red when charging. Once the battery is fully charged, the LED turns green. The battery takes about 45 minutes to charge.

Installing the battery

Slide the battery into its compartment until you hear a "Click". The latch at the rear of the battery must be locked in the lower position.

To remove the battery, hold the latch up, and slide the battery backward.

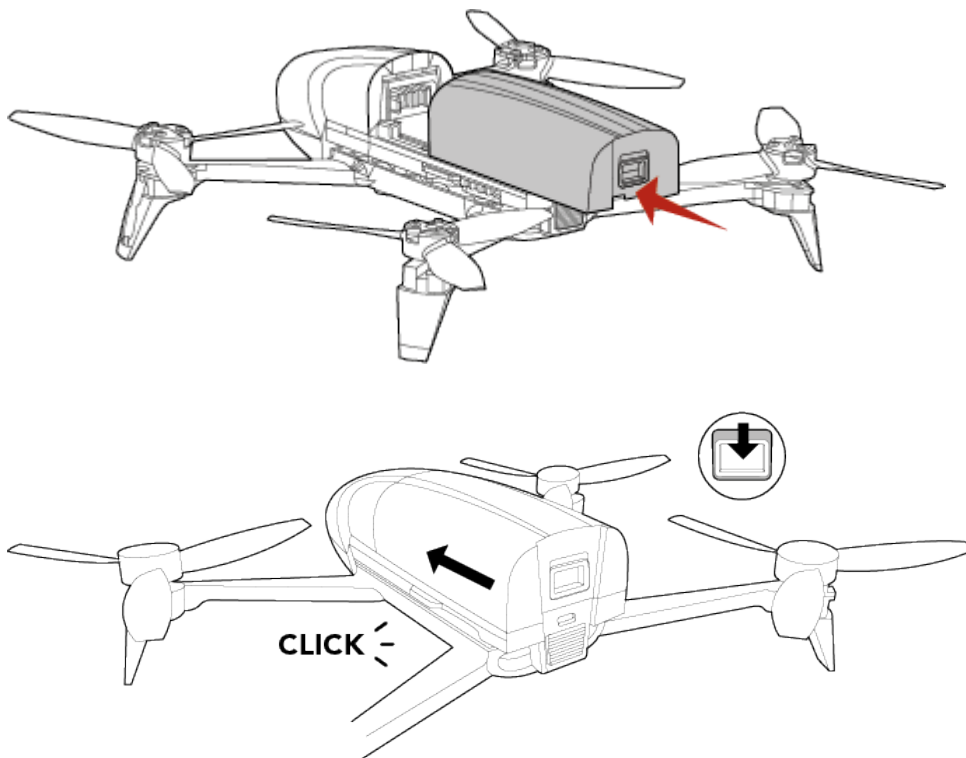

Switching on/off the Parrot Bebop 2

To switch your Parrot Bebop 2 on/off press the on/off button located on the back of the Parrot Bebop 2.

> The LED located on the on/off button flashes red. The Parrot Bebop 2 omits a sound. Once it is fully booted and ready for use, the button stays red.

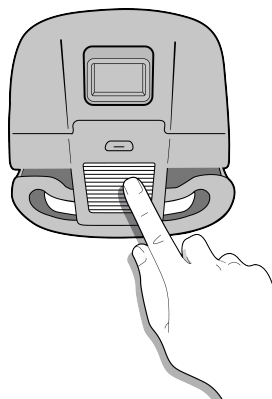

Downloading the application

Connect to the App Store™ or Google Play™ and download the FreeFlight Pro application for free.

Connecting a smartphone

1. Switch the Parrot Bebop 2 on.
 2. On your smartphone, carry out a search for Wi-Fi® networks available:
 - if you are using an iPhone or an iPad, select **Settings > Wi-Fi**;
 - if you are using an Android™ smartphone, select **Settings > Wireless and networks > Wi-Fi**.
 3. Select the network: Bebop2_XXXXX.
 4. Wait for your smartphone to connect to the Wi-Fi network of the Parrot Bebop 2. This connection is generally represented by the Wi-Fi logo appearing on the smartphone screen.
 5. Launch the FreeFlight Pro application.
 - > The connection between your smartphone and the Parrot Bebop 2 is established automatically.
- See the [Network settings](#) section for further information.

Preflight check

Prior to piloting your Parrot Bebop 2 please read the following guidelines and recommendations:

Regulation

- Make sure that you have authorization to pilot the Parrot Bebop 2 in the area you intend to fly. In some areas flying a drone is not permitted, such as military bases, parks, cities and airports.
- Check local regulations prior to flying. You are required to keep visual contact with your drone, do not take your drone out of line of sight.
- Check local regulations regarding Wi-Fi and Wireless networks.
- Check local regulations regarding video recording, storage and use.
- Local regulation may require a license or specific documents in order to pilot the Parrot Bebop 2.

Flight conditions check

- Do not pilot the Parrot Bebop 2 at night.
- Check weather conditions. Do not pilot the Parrot Bebop 2 whilst it is raining, snowing or in a foggy environment.
- Do not pilot the Parrot Bebop 2 if the wind speed exceeds 40 km/h (25 mph).
- Do not pilot the Parrot Bebop 2 over water.

Parrot Bebop 2 pre-flight check

- Check each propeller and confirm it is correctly and securely installed.
- Make sure both your Parrot Bebop 2's battery and your smartphone battery are fully charged.
- Calibrate the Parrot Bebop 2.
- Ensure you have a valid GPS signal before taking off. The GPS icon must be green.

Updating the Parrot Bebop 2

1. Launch the FreeFlight Pro application.
2. Press **Check for updates** to check if any updates are available for the Parrot Bebop 2.

There are 2 ways to update the Parrot Bebop 2:

- via the FreeFlight Pro application (recommended)
- via USB, by downloading the update file from our website. A computer is necessary for this method.

Note: Ensure that the battery of the Parrot Bebop 2 is in place and fully charged before updating via USB.

For further information, refer to the [Parrot Bebop 2 update procedures section](#).

Via the app

1. Connect your drone to your smartphone and open the FreeFlight Pro app.
2. In FreeFlight Pro, press **Check for updates**.
3. Follow the on-screen direction to download and install updates.

Via USB

1. Go to Parrot Bebop 2's support page at https://community.parrot.com/t5/Bebop-2/bd-p/Bebop_2.
2. Under DOWNLOADS, click Software update to download the update file (.plf).

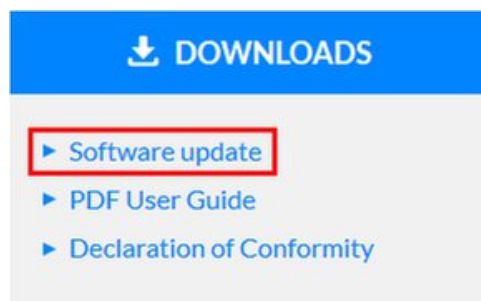

3. Move that file (bebop2_update.plf) to an empty USB flash drive (formatted to FAT32), and place it in the USB's root directory. DO NOT RENAME THE FILE.
4. Connect the USB flash drive to the OTG adapter, then insert it into the Micro-USB port on the Bebop 2, and then power on the drone. Bebop 2 begins updating.

5. The update is completed when the drone finishes rebooting.

Downloaded from www.vandenborre.be

Flying

Note: Joypad piloting mode is activated by default. To change mode, refer to the Piloting settings section.

1. Launch the FreeFlight Pro application.
2. Wait until the connection between your smartphone and the Parrot Bebop 2 is complete.
3. Press **Start** to pilot the Parrot Bebop 2.
 - > The piloting screen appears. It locks in landscape format.

Piloting screen

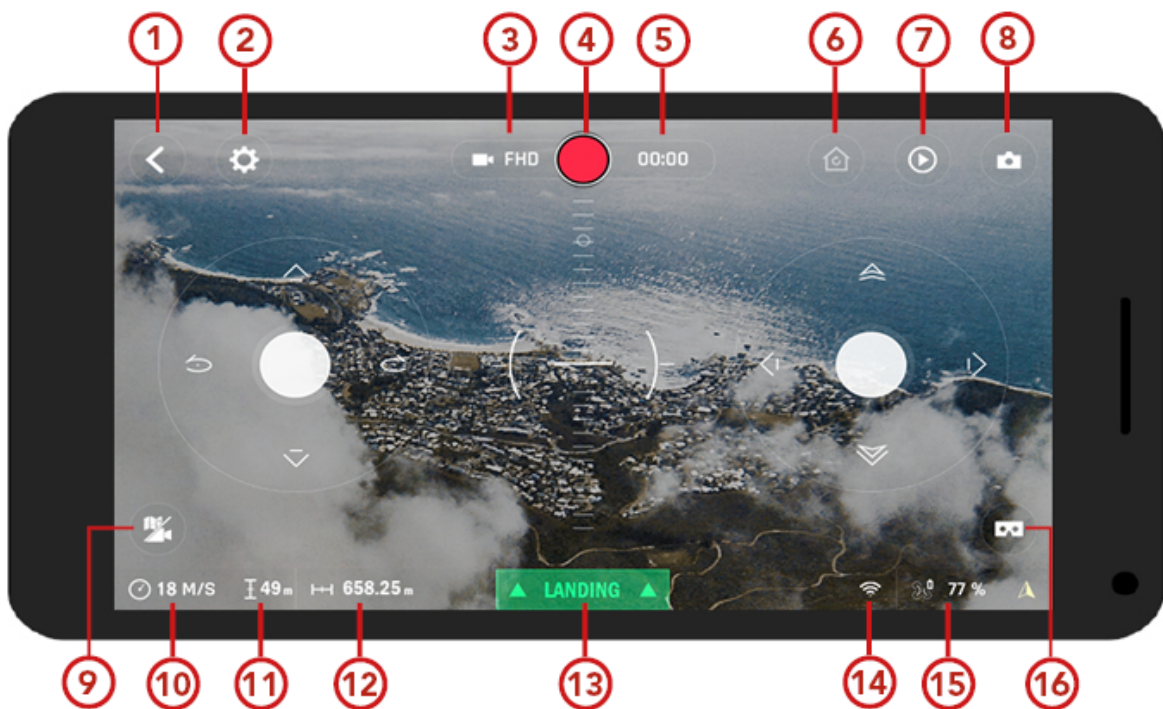

#	Description	#	Description
1	Previous screen	9	Map mode
2	Settings	10	Speed
3	Recording resolution: Full HD (1080p) or HD (720p) NB: define the recording resolution in the	11	Altitude

settings. When you record a video in 1080p, the live return video feed is 480p. When you record a video in 720p, the live return video feed is 720p

4	Video recording	12	Distance from your smartphone
5	Video recording time	13	Take off/Landing
6	Return home	14	Wi-Fi signal
7	Pre-programmed acrobatics	15	Battery level of the Parrot Bebop 2
8	Take a photo	16	FPV mode

Calibrating the Parrot Bebop 2

When you use the Parrot Bebop 2 for the first time, the calibration screen appears.

1. Follow the procedures on the screen.
2. Once you completed the three steps, press .

Note: You can also calibrate your Parrot Bebop 2 if it is unstable in flight. To do so, go to  > Position, distance and limits.

Flat trim

The flat trim setting is a means to reset the sensors to a horizontal plane. This is used if your drone is unstable in flight or following a crash.

To flat trim:

1. Place the Parrot Bebop 2 on a flat, dry, unobstructed surface.
2. In the FreeFlight Pro application, go to  > **Position, distance and limits**.
3. Press **Flat Trim**.

GPS signal

Note: If you are in an area with no GPS reception, the Parrot Bebop 2 position will not be detected.

The  icon indicates that the Parrot Bebop 2 position is not detected.

The  icon indicates that the Parrot Bebop 2 position is detected.

Make sure the Parrot Bebop 2 position is detected before taking off to register the starting point correctly.

To display the last GPS position of the Parrot Bebop 2:

1. Launch FreeFlight Pro.
2. On the main screen, go to **FLY & FILM** > **Settings**.
3. Press **See details**.
 - > The latitude and longitude of the Parrot Bebop 2 position appears in the list.

Taking off

1. Place the Parrot Bebop 2 on a flat and dry surface and in a unobstructed and lit area.
2. Press **Take Off**.
 - > The Parrot Bebop 2 takes off and hovers at approximately 1 meter above the ground.

Note: Make sure the take-off location of the Parrot Bebop 2 is saved. To do so wait for the  icon to turn green.





Movements

Movements depend on the flight and piloting settings. See the [Settings](#) section for further information. By default, the **Joypad** option is activated and **inverted** option is deactivated.

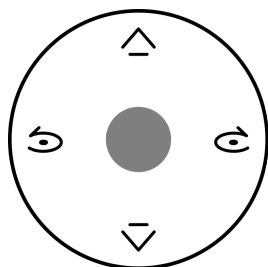
Joypad mode

Left joypad



-  rotate to the left
-  rotate to the right
-  fly upwards
-  fly downwards

Right joypad

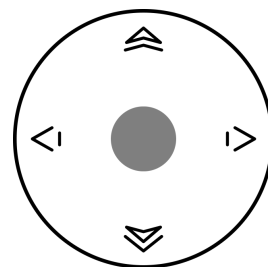



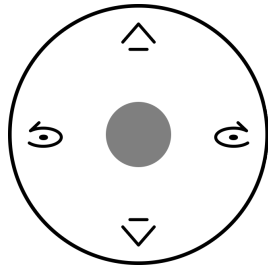

-  fly forwards
-  fly backwards
-  fly right
-  fly left

Normal mode

Left joypad



-  rotate to the left
-  rotate to the right
-  fly upwards
-  fly downwards

Right joypad



Hold the central button and tilt your smartphone to fly the Parrot Bebop 2.

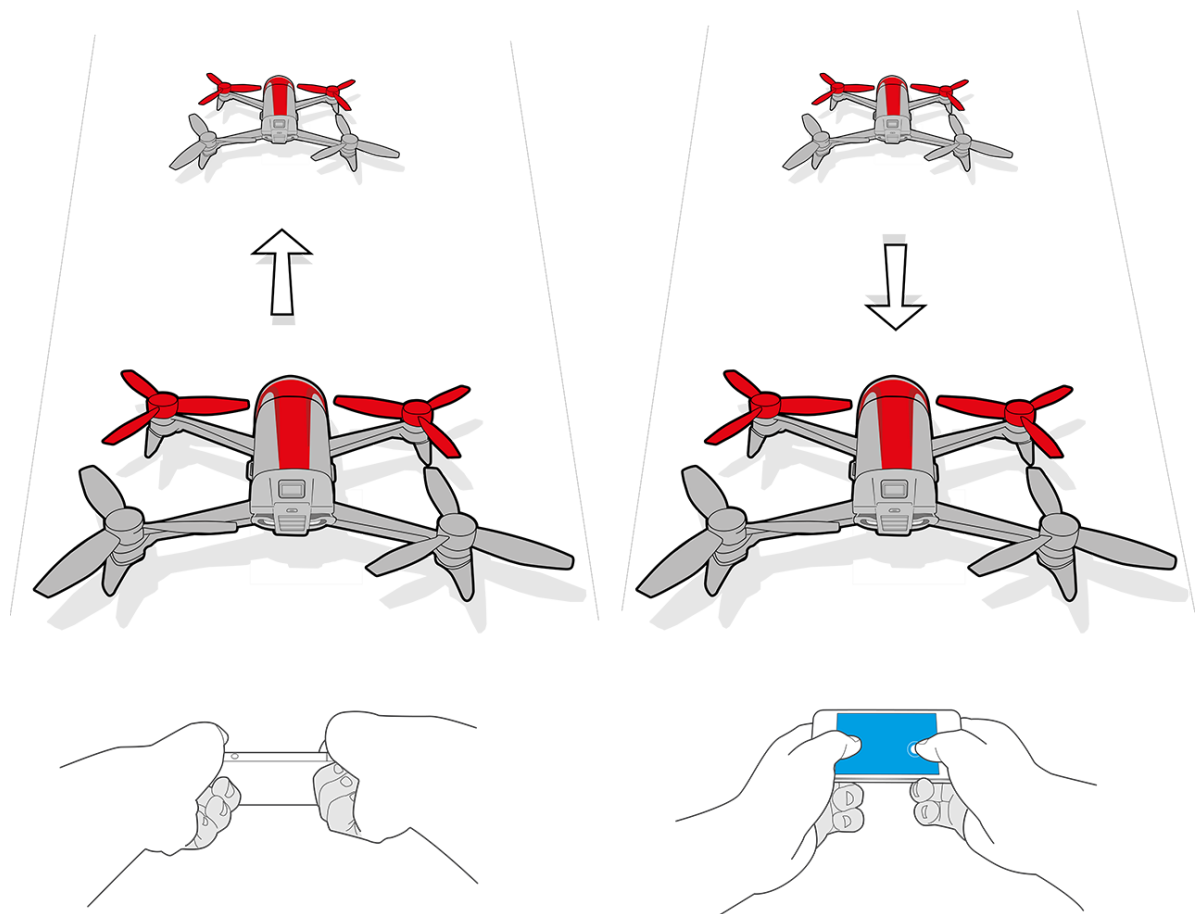

Hold the central button and tilt your smartphone forwards or backwards to pilot the Bebop 2 forwards or backwards.

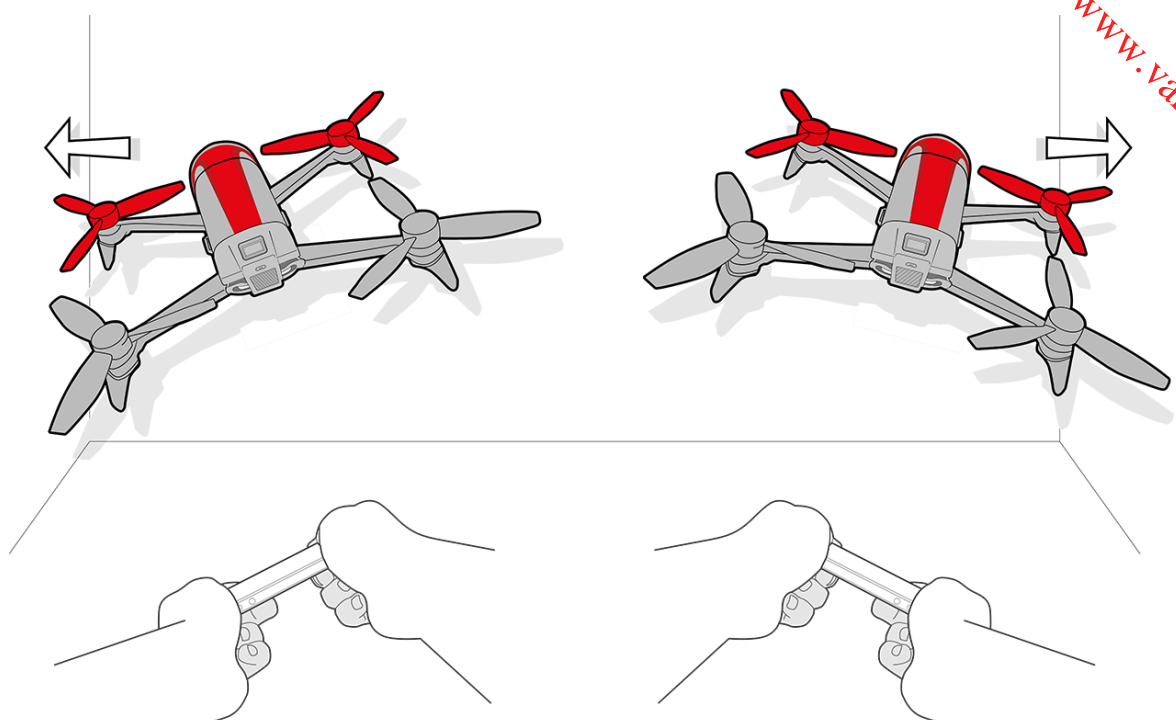



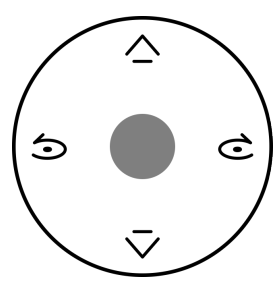

Hold the central button and tilt your smartphone to the left or right to fly the Bebop 2 to the left or right.

Ace mode

Left joypad



-  rotate to the left
-  rotate to the right
-  fly upwards
-  fly downwards

Hold the central button and tilt your smartphone to fly the Parrot Bebop 2.

Right joypad

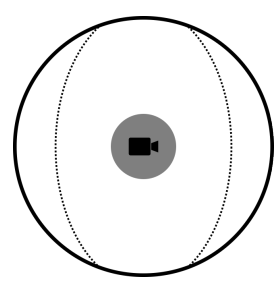

Slide  to orientate the camera regardless of the position of the Parrot Bebop 2.





Landing

Ensure that the Parrot Bebop 2 is over a flat, dry and unobstructed surface, then press **Landing** to make the Parrot Bebop 2 land.

Pre-programmed acrobatics

The Parrot Bebop 2 can perform acrobatics while flying, whether it is stationary or moving.

1. Press the flip icon to change the flip.  is selected by default.

	back flip
	front flip
	left flip
	right flip
	no flip

2. Tap on your smartphone screen twice to perform a flip.

Battery

The Parrot Bebop 2 has a battery life of approximately 25 minutes.

When the battery level is low, an alert appears on your smartphone screen. The Parrot Bebop 2's on/off button lights up twice and shuts off.

Note: The number of acrobatics can have an impact on the Parrot Bebop 2's battery life.

Return home

*Note: If neither your smartphone nor the Parrot Bebop 2 receives a GPS signal, the **Return home (RTH)** feature cannot be activated.*

The **Return home** feature enables you to make the Parrot Bebop 2 fly back to:

- the last take off location,

- your smartphone location if the Parrot Bebop 2 has received no GPS signal.

Note: To locate your position on the map, the FreeFlight Pro application must have access to your smartphone location services. For iOS devices, activate the function in Settings > FreeFlight Pro > RTH. For Android devices, activate the function in Settings > Application manager > FreeFlight Pro > Permissions. For further information, see your smartphone user guide.

Press  for the Parrot Bebop 2 to return to its starting point.

> The  button turns green and the Parrot Bebop 2 returns to its starting point. Once the Parrot Bebop 2 reaches its starting point, it remains at 2 meters above the ground.

Warning: The Parrot Bebop 2 returns to its starting point in a straight line. The Parrot Bebop 2 cannot automatically avoid obstacle in its trajectory.



You can take control over the Parrot Bebop 2 when it is returning to its starting point.

If the Parrot Bebop 2 altitude is below 20 meters, it will rise to an altitude of 20 meters before returning to its starting point. This decreases the chance of colliding into obstacles.

If the connection between your smartphone and the Parrot Bebop 2 is lost, the Parrot Bebop 2 returns to its starting point automatically after a certain period of time. To set this period of time. Within the FreeFlight Pro application, go to **Settings > RTH** and set the desired period of time.

Map mode

You can display a map instead of the camera video feedback to see the position of your Parrot Bebop 2.

Before activating the map mode:

- preload a map. If you fly the Parrot Bebop 2 in an area without internet connection, or

if the internet connection is lost while flying, the Parrot Bebop 2 will still be located on the map.

- wait until the 🌀 icon turns green to indicate the Parrot Bebop 2 GPS position is detected.

Activating map mode

Press 📶.



The 🏠 icon indicates your smartphone's position.

The 🌀 icon indicates the Parrot Bebop 2 position.

To switch back to the video mode, press 📶 again.

Photos and videos

Note: The camera is located at the front on the Parrot Bebop 2. The camera located under the Parrot Bebop 2 is for stabilization only.

You can set the Parrot Bebop 2 in video or photo mode. The video mode is activated by default. For further information, refer to the [Recording settings section](#).

Orienting the camera Control the angle of the camera regardless of the Parrot Bebop 2 position.

- in **Normal** and **Joypad** modes: slide two fingers on the screen.

Note : The vertical orientation commands are reversed. If you slide your finger upwards, the camera angle will move downwards. If you slide your finger downwards, the camera angle will move upwards.

- in **Ace** mode : slide 📺.



Taking a photo Press 📷 to take a photo.

The internal memory of the Parrot Bebop 2 is 8GB. The maximum

number of photos stored in the internal memory depends on the selected format. To choose a photo format, see [Recording settings](#). Once the memory is full, it is no longer possible to take a photo.

Note: To obtain high quality photos, make sure that the Parrot Bebop 2 is set in photo mode. To do so, refer to the [Recording settings section](#).

Recording a video The video recording starts automatically when you press **Take off**. The  button blinks during recording.

To stop the video record, press . To start a new video, press  again. The video recording stops after 29 minutes of recording.

Note: It is not possible to record a video when the Parrot Bebop 2 is set in timelapse mode. To deactivate timelapse mode, refer to the [Recording settings section](#).

Retrieving photos and videos

You can retrieve photos and/or videos taken with the Parrot Bebop 2:

- on your smartphone, using the FreeFlight Pro application,
- on your computer, using a USB/micro USB cable (supplied).

Retrieving photos and videos on your smartphone

1. On your smartphone or tablet, launch the FreeFlight Pro application.
2. Go to **Internal memory**. The list of photos and videos stored in the Parrot Bebop 2 internal memory opens.
3. Select one or several photos and/or videos.
4. Tap **Transfer** to retrieve the photos and/or videos on your smartphone.
5. Tap **Delete** if you want to delete the photos and/or videos from the internal memory of the Parrot Bebop 2.

Retrieving photos and videos on your computer

- Windows :

1. Connect the Parrot Bebop 2 to your computer with the USB/micro USB cable (supplied).

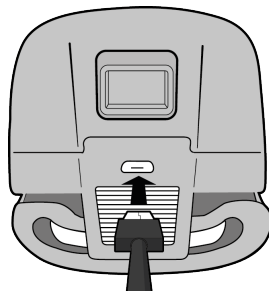

2. Switch the Parrot Bebop 2 on.

> Your computer detects the Parrot Bebop 2 automatically. Wait until the driver installation is complete. A pop-up appears like the one shown below.

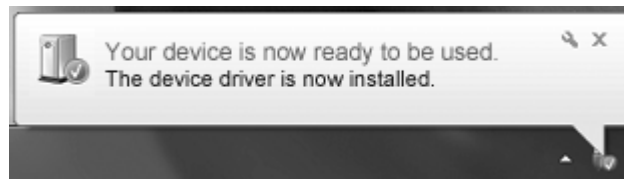

The appearance, content and location of this message depends on your operating system.

3. Open the file, as though it were a USB flash drive.

> You can copy the photos and/or videos on your computer.

- Mac :

3. Connect the Parrot Bebop 2 to your computer with the USB/micro USB cable (supplied).

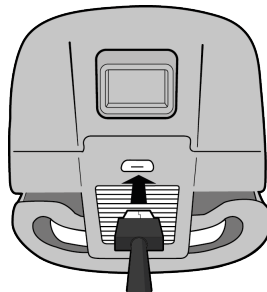

4. Switch the Parrot Bebop 2 on.

> Your computer detects the Parrot Bebop 2 automatically and the Photos application opens. You can copy the photos and/or videos on your computer.

Settings

Within the FreeFlight Pro application, press  to access the Parrot Bebop 2 settings menu.

Slide the screen right or left to access the different settings screens.

Press  to reset the Parrot Bebop 2 to factory settings. This action deletes your settings and preferences, photos and videos stored in the Parrot Bebop 2's internal memory.

Note: You can also reset the Parrot Bebop 2 without the Parrot Bebop 2 application. To do so, switch the Parrot Bebop 2 on and press the on/off button for 10 seconds.

Piloting settings

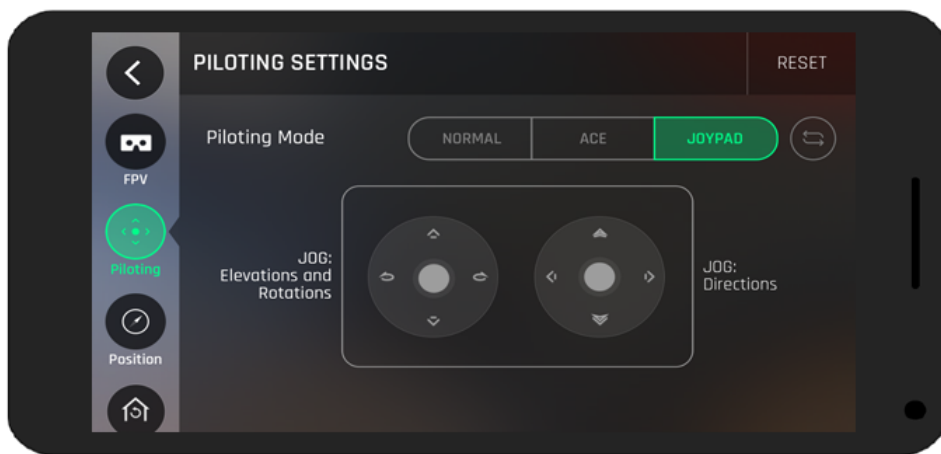

Piloting mode	Three piloting modes are available: Normal , Joypad (activated by default) and Ace . For more information about these modes, see the Movement section.
Joypad inverted	Reverse the controls on your smartphone.

Position, distances and limits

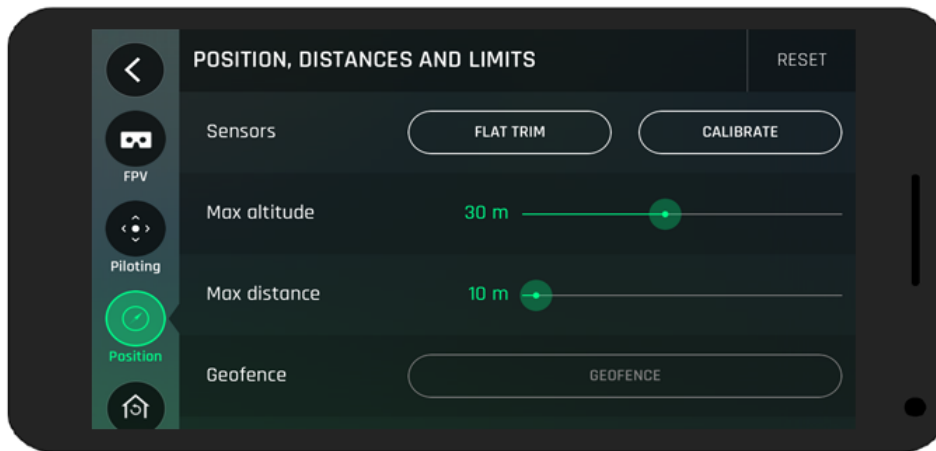

Sensors

Flat Trim: resets the accelerometer and indicates the horizontal position to it. Make a Flat trim before each flight. To do this, connect to your drone, lay it on a flat surface and tap **Flat Trim**.

Calibrate: tap **Calibrate** to calibrate your drone. Follow the instructions on your smartphone screen to calibrate your drone.

Max altitude

Define a maximum altitude when you fly the Parrot Bebop 2 upwards. When the Parrot Bebop 2 is about to reach this limitation, it stabilizes at the altitude selected.

Max Distance

Define a maximum distance when you fly the Parrot Bebop 2. When the Parrot Bebop 2 is about to reach this limitation, an alert message appears on your smartphone.

Note : Before using this feature, make sure the GPS icon is green.

Geofence

Enable or disable the geo-fence. If the geo-fence is on, the drone will turn around once it's boundary (Max distance) is reached. If the geo-fence is off and your drone exceeds the maximum distance, the distance on the screen of your smartphone is displayed in red and the Parrot Skycontroller 2 vibrates.

Recording settings

The Parrot Bebop 2 is equipped with a fisheye (wide-angle) camera.

Note: The camera lens is situated at the front of the Parrot Bebop 2.

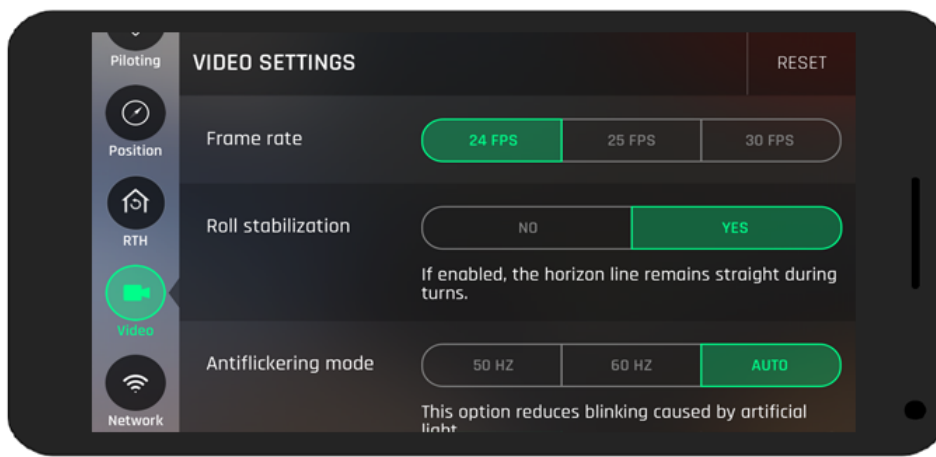
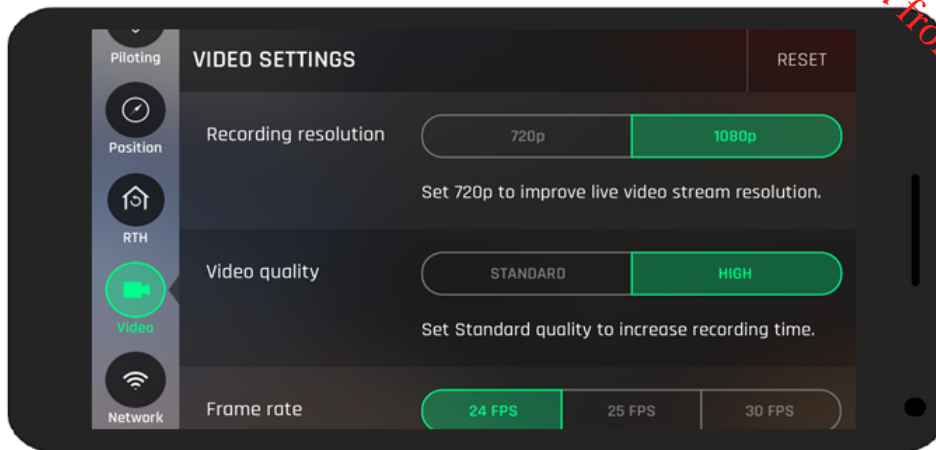

Recording resolution	Recording resolution: Full HD (1080p) or HD (720p) NB: define the recording resolution in the settings. When you record a video in 1080p, the live return video feed is 480p. When you record a video in 720p, the live return video feed is 720p
Video quality	Set the video quality: standard or high .
Frame rate	Set the frame rate.
Roll stabilization	Enable roll stabilization.
Antiflickering mode	Delete the flickering effect on the video. Select this to reduce the flickering effect observed when videoing indoors under florescent lighting. Select Auto to adapt the frequency to the country selected on the Network settings screen.

Photo mode	Activate the photo feature.
Video mode	Activate the video feature. This mode is activated by default.
DNG	Select this format to take high resolution photos.
JPEG	Select this format to take medium resolution photos.
JPEG 180°	Select this format to keep the Fisheye effect on your photos. <i>Note : This format does not save the picture's metadata.</i>
Timelapse mode	Activate Timelapse mode : <ol style="list-style-type: none">1. Press Timelapse mode.2. Slide your finger on the circle to select the interval between each photo. If you select 10", the Parrot Bebop 2 will take a picture every 10 seconds. <p><i>Note : When the Parrot Bebop 2 is set in timelapse mode, it is not possible to record a video.</i></p> <p><i>Note : When the DNG option is activated, the timelapse mode enables the Parrot Bebop 2 to take a picture every 10 seconds minimum. When the JPEG option is activated, the timelapse mode enables the Parrot Bebop 2 to take a picture every 8 seconds minimum.</i></p>

Return home

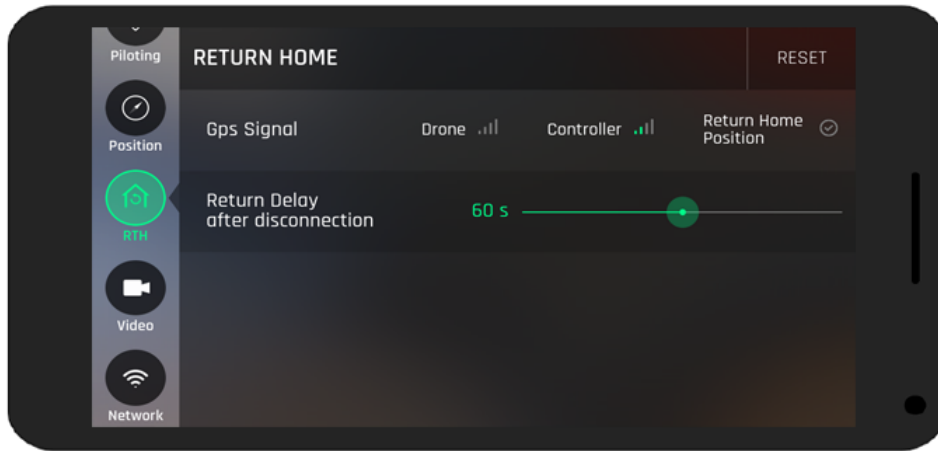

GPS signal

This section shows the quality of the GPS signal of the drone, the Parrot Skycontroller 2 and whether or not the return home point is stored.

NB: Do not fly your drone if the Return Home position is not set. Your drone will not be able to automatically return to its starting point.

Return time after disconnection

During the flight, in case of connection loss, the drone automatically returns to its starting position after a certain time period (10 seconds by default). Set this time in this section.

Image settings

To access image settings:

1. On your smartphone, launch the FreeFlight Pro app.
2. Go to **FLY & FILM**.
3. Tap the icon to the left of the save button.

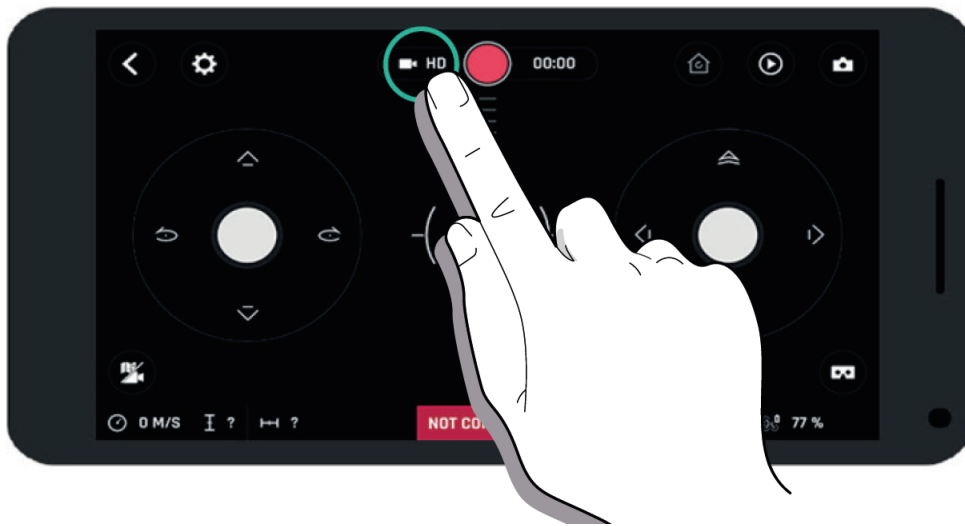

The image settings appear:

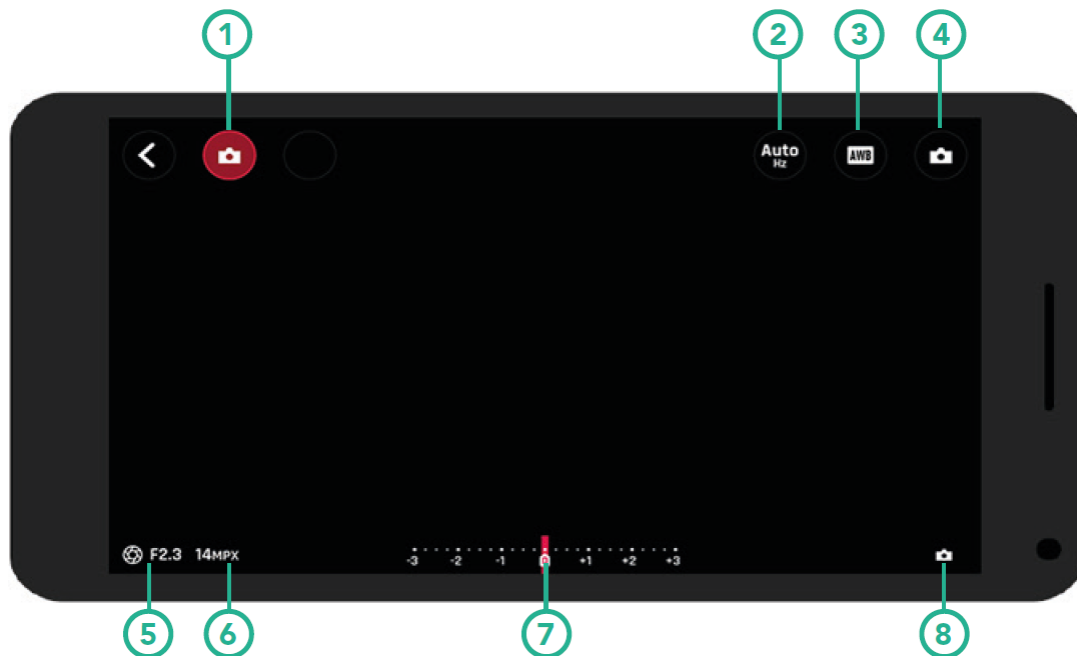

- 1 Mode
- 2 Anti-flicker settings
- 3 White Balance
- 4 Take a photo
- 5 Lens aperture
- 6 Image resolution
- 7 Image exposure
- 8 Photo mode status

Network settings

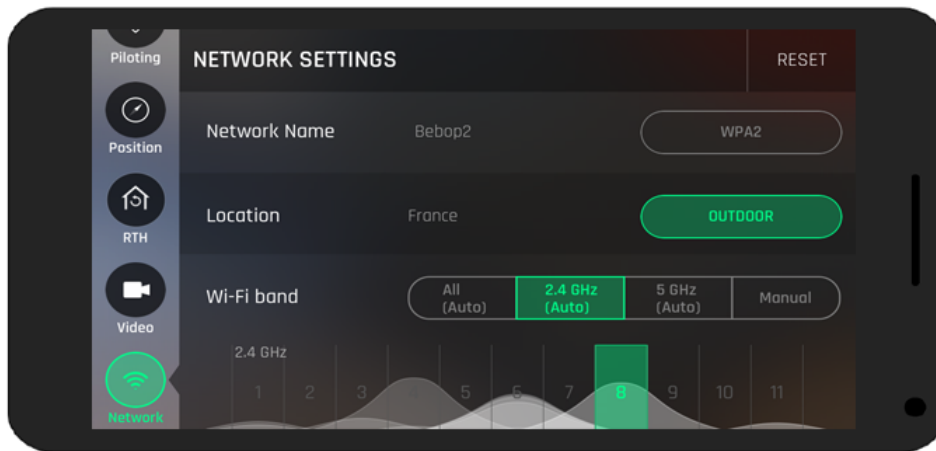

Network Name

Change the network name of your Parrot Bebop 2:

1. Change the Parrot Bebop 2 name in the **Product name** field.
2. Reboot the Parrot Bebop 2.

Note: The network name of the Parrot Bebop 2 can only contain letters, numbers and underscores ("_"). It must not exceed 32 characters in length.

WPA2

Set a password for your Parrot Bebop 2's Wi-Fi network.

Location

Select your country.

Wi-Fi band

Connect the Parrot Bebop 2 to the 2.4 or 5 GHz Wi-Fi bands.

- The 2.4 GHz Wi-Fi band enables you to fly the Parrot Bebop 2 from a greater distance. It is generally more congested than the 5 GHz Wi-Fi band in urban areas.
- The 5 GHz Wi-Fi band enables you to obtain a better quality connection between the Parrot Bebop 2 and your smartphone for streaming footage. Check your smartphone user guide (or the technical specifications) to see whether it supports connection to the 5 GHz Wi-Fi band. If it does not, use the 2.4 GHz Wi-Fi band only.

To switch the Wi-Fi band (2.4 GHz or 5 GHz) manually without using the application, hold down the on/off button of the Parrot Bebop 2 for 5 seconds .

Note : The diagram at the bottom of the screen shows the state of the Wi-Fi channels. Red curves represent congested channels. Green curves represent less congested channels. The channel without curves are free.

Before flying the Parrot Bebop 2, ensure that you comply with the Wi-Fi frequencies restrictions for the area in which you intend to fly. Certain frequencies may be restricted or forbidden. Selecting the country and activating the outdoor option enable FreeFlight Pro to adapt the available channels according to the legislation of the selected country. For example, in certain countries using the 5 GHz Wi-Fi band may be prohibited in outdoor mode.

In automatic mode, FreeFlight Pro automatically selects a channel according to the country, the mode (outdoor/indoor), and the Wi-Fi band selected and the congestion of the channels.

If you encounter a problem with the quality level of the Wi-Fi connection:

1. Select **Manual mode**.
2. Select a non-overloaded channel using the information displayed on the diagram. Give preference to channel without curves or with green curves.

Information

Access to your drone's information via the FreeFlight Pro app. To do so, go to the main screen and press the names of your drone.

Note : your drone must be connected to your smartphone.

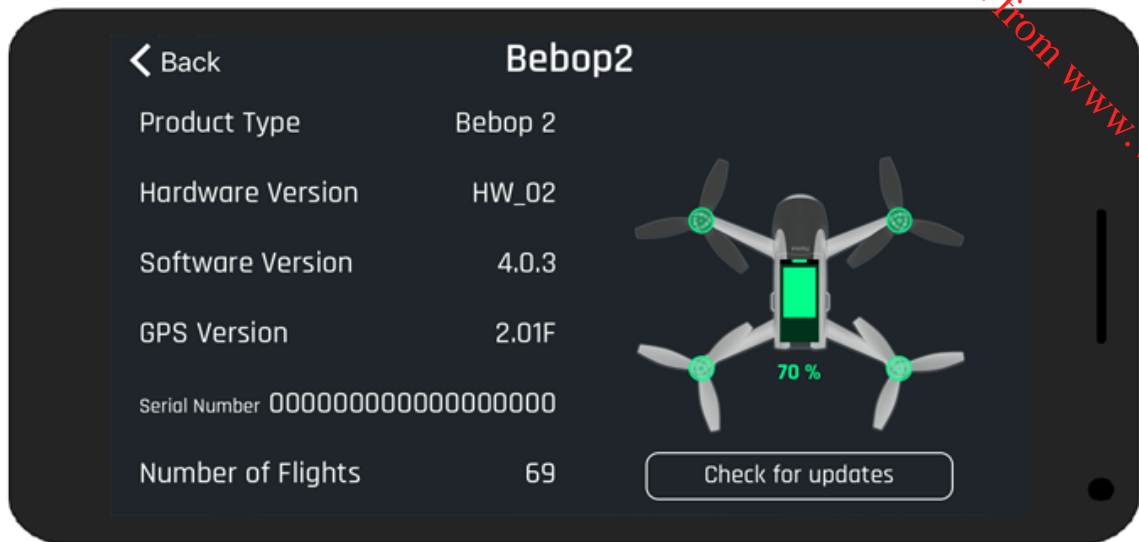

Informations

- Product type
 - Hardware version
 - Software version
 - GPS hardware version
 - Serial number of your drone
 - Number of flights
 - Motor information
-

Drone Academy

Note: An internet connection is necessary to use the Drone Academy.

To launch Drone Academy:

1. Launch the FreeFlight Pro application.
2. Press **Drone Academy**.

Creating a user account

You need a user account to use Drone Academy.

1. Press **Sign up now**.
2. Type a user name, a password and an e-mail address.
3. Press **Register your profile**.

Registering a drone

To register a drone, press **My Drones**.

Note: The first time you connect the Parrot Bebop 2 to your smartphone, a pop-up asks you to register your Parrot Bebop 2 in the Drone Academy.

Managing your profile

To modify or delete your profile:

1. Press the **Profile** tab.
2. Press **⚙️**.
3. Press **Logout** or **Edit**.
4. If you edit your profile, scroll to the left to access all pages and to complete your profile.

Consulting shared flights

1. Press **Map**.
2. Press **👁️** to search flights amongst:

- your flights or other user's flights
- the type of media.

Press  to search flights by user or by location.

Consulting and sharing your flights

1. Press **My pilotings**.
 - >The list of your flights appears. You can sort them by date, rank or type.
2. Press the flight you want to share.
3. Press **Public** to share the flight. You can also:
 - press the stars to rate the flight.
 - press the tabs at the bottom of the screen to view the flight information.

Troubleshooting

LED behaviour

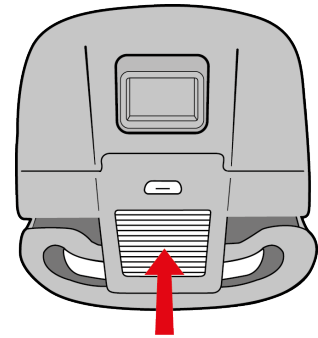

Behavior	Signification
Steady red	Normal state.
Slowly blinking red	The Parrot Bebop 2 is booting up.
Quickly blinking red	A motor error is detected. To locate the defective motor: <ol style="list-style-type: none">1. In FreeFlight Pro, press Start.2. Press  > Motor information. >The screen indicates the defective motor.3. Ensure the propeller is not blocked or damaged.

Spare parts

You can buy spare parts of the Parrot Bebop 2 on our [online store](#).

For further information about replacing spare parts, see the video tutorials on our [support page](#).

More information

For more information, go to [the Parrot Bebop 2's support page](#) or [download the app user guide](#).

General information

The pilot must operate his/her Parrot Bebop 2 in his/her line-of-sight at all times in order to avoid any obstacles, and must take care only to use it in suitable locations chosen to ensure that people, animals and property remain safe at all times.

The internal memory for video recording is limited to 29 minutes.

Before flying your Parrot Bebop 2, check your local civil aviation regulation for your country and read the guidelines on www.parrot.com.

Safety precautions and maintenance

The Parrot Bebop 2 is not suitable for children under 14 years of age.

The Parrot Bebop 2 is a model aircraft designed for recreational and leisure purposes. The pilot must always maintain direct visual contact with the Parrot Bebop 2 and monitor its trajectory. The Parrot Bebop 2 must be used in accordance with the civil aviation regulations in your country. You should only use the Parrot Bebop 2 in open spaces so that you can ensure the safety of people, animals and property at all times. There are some public places such as train stations, airports, etc., and roads where you may not be permitted to use your Parrot Bebop 2.

During flight, the propellers of the Parrot Bebop 2 can cause injury to people and damage property.

Do not touch the Parrot Bebop 2 while it is in flight! Wait until the propellers have completely stopped before handling the Parrot Bebop 2.

Only use accessories specified by the manufacturer.

Irreversible damage may be caused if sand or dust get into the Parrot Bebop 2. Should this occur, your drone may not function as intended.

Do not use the Parrot Bebop 2 in adverse weather conditions such as rain, strong winds, and snow, or in poor visibility conditions, for example, at night.

Keep the Parrot Bebop 2 away from high voltage power lines, buildings or any other potentially dangerous areas.

Do not use this device near liquids. Do not land the Parrot Bebop 2 on water or any wet surface as this may cause irreversible damage.

Avoid subjecting the Parrot Bebop 2 to any sudden significant changes in altitude. Do not leave the Parrot Bebop 2 in sunlight.

Risk of ingestion of small parts. The packaging is not part of the product and should be

disposed of for safety reasons.

Warning on invasion of privacy

Recording and circulating an image or the voice of a person without their consent could constitute an infringement of their image and privacy rights and incur your liability. Ask for consent before filming people and recording their voices, particularly if you want to keep your recordings and/or share them on the Internet.

Do not share any degrading images or sounds which could undermine the reputation or dignity of an individual.

Warranty

For warranty conditions please refer to the retailer's General Conditions of Sale where you purchased your Parrot Bebop 2.

Wi-Fi

Before flying the Parrot Bebop 2, please ensure that you comply with the Wi-Fi frequencies restrictions in the area you intend to fly. Certain frequencies may be restricted or forbidden. For example, in certain countries using the 5 GHz Wi-Fi band may be prohibited in outdoor mode.

Battery

Read the entire instruction sheet included with this battery. Failure to follow all instructions could cause permanent damage to the battery and its surroundings, and cause bodily harm. Never use anything except a LiPo approved charger. Always use a LiPo cell balancing charger or a LiPo cell balancer. Never charge through the discharge lead. Never trickle charge, or allow to discharge below 2.5V per cell. Never allow the battery temperature to exceed 140°F (60°C). Never disassemble or modify pack wiring in any way or puncture cells. Never place on combustible materials or leave unattended during charge. Always charge in a fireproof location. Always set charger's output volts to match battery volts. Always keep out of reach of children. Improper battery use may result in a fire, explosion or other hazard.

The battery terminals should not be allowed to short-circuit. The product should be



connected only to class II appliances which display the symbol.

Modifications

The explanations and specifications in this guide are given for information purposes only and may be modified without prior notice. They are deemed to be correct at time of going to press. The utmost care has been taken when writing this guide, as part of the aim to provide you with accurate information. However, Parrot shall not be held responsible for any consequences arising from any errors or omissions in the guide, nor for any damage or accidental loss of data resulting directly or indirectly from the use of the information herein. Parrot reserves the right to amend or improve the product design or user guide without any restrictions and without any obligation to notify users. As part of our ongoing concern to upgrade and improve our products, the product that you have purchased may differ slightly from the model described in this guide. If so, a later version of this guide might be available in electronic format at Parrot's website at www.parrot.com.

Disposal of this product at the end of its life



At the end of this product's life, please do not dispose of this product in your general household waste. Instead, in order to prevent possible harm to the environment or human health from uncontrolled waste disposal, please dispose of this product separately in accordance with your local laws and regulation. For more information on the separate collection systems for waste electrical and electronic equipment that are available for consumers, near your home, free of charge, please contact your local municipality authority. You can also contact the retailer from which you purchased your Parrot Bebop 2 he might have put in place recycling services or he may be part of a specific recycling scheme.

Declaration of conformity



This equipment may be operated in: DE, AT, BE, BG, CY, HR, DK, ES, EE, FI, FR, GR, HU, IE, IT, LV, LT, LU, MT, NL, PL, PT, CZ, RO, GB, SK, SI, SE.

The restriction concerns only the first sub-band of the 5 GHz band (5150-5250 MHz) for an outdoor use within the member states of the European Union.

Parrot Drones SAS, 174 quai de Jemmapes, 75010 Paris, France, declare under their sole responsibility that the product described in this user guide complies with technical

standards EN 301489-1, EN 301489-3, EN 301489-17, EN 62311, EN300328, EN301893, EN300 440-2, EN71-1, EN71-2, EN62115, EN50581 following the provision of the Radio Equipment, Telecommunication Equipment directive (1999/5/EC R&TTE), and of the General Safety directive (2001/95/EC) and of ROHS directive 2011/65/EC.

<http://www.parrot.com/uk/ce/?bebop-2>

Registered trademarks

Parrot, Bebop Drone and the Parrot logo are registered brands of Parrot Drones SAS.

iPhone and iPad are Apple Inc. brands registered in the USA and in other countries. App Store is an Apple Inc. service mark.

Google Play and Android are Google Inc. brands.

Wi-Fi® is a Wi-Fi Alliance registered brand.

All other brands mentioned in this guide are protected and the property of their respective owners.